

Bottom view
Scale: 1:1

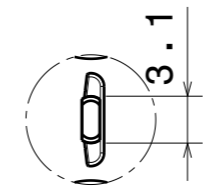

Detail D
Scale: 2:1

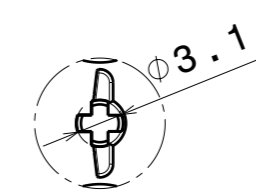

Detail E
Scale: 2:1

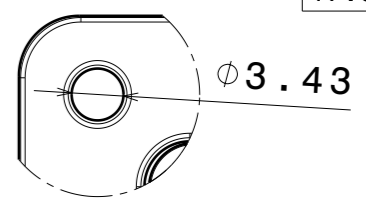

Detail F
Scale: 2:1

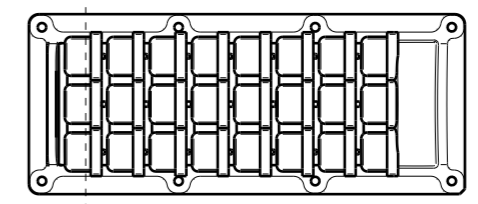

Front view
Scale: 1:3

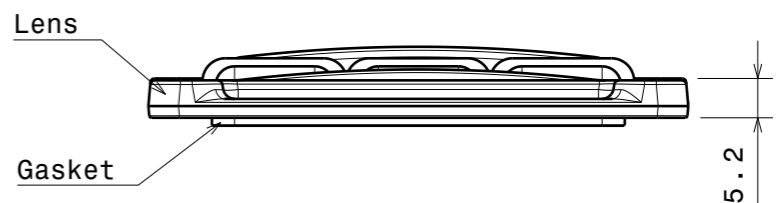

Front view
Scale: 1:1

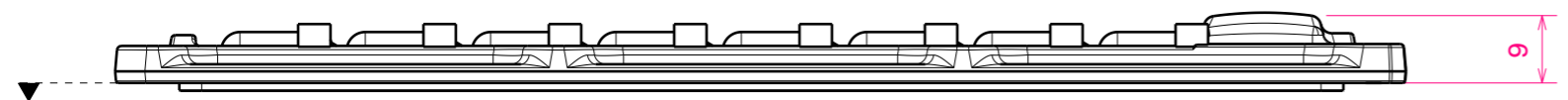

Right view
Scale: 1:1

Heatsink level

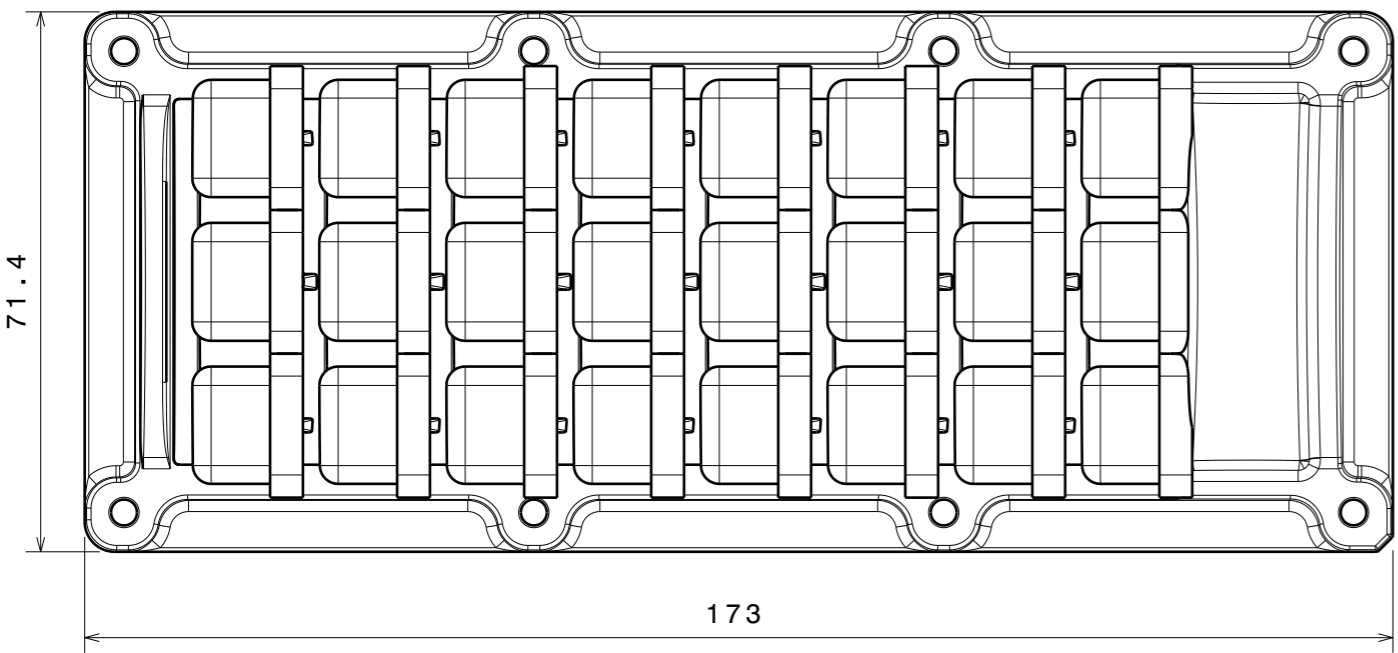

Top view
Scale: 1:1

Notes

- PCB or heatsink level.
- LED location

Ensure LED fitting from a product specific 3D model available from www.ledil.com

For more details about installation please see LEDiL Installation Guide on www.ledil.com

PART	TYPE	MATERIAL	COLOR / COATING
C17756_STRADA-IP-24-SEAL	gasket	Silicone	White
C18398_STRADA-IP-24-SCL	lens	PMMA	Clear

MECHANICAL DRAWING	
PRODUCT CS18400_STRADA-IP-24-SC	
Plastic moulding general tolerances according to DIN 16901-130 and applies if not otherwise shown in the drawing. Silicone moulding general tolerances according to ISO 3302-1 Class M3 and applies if not otherwise shown in the drawing.	FIRST ANGLE PROJECTION:
SCALE 1:1	WEIGHT g

LEDiL

This drawing is the property of LEDiL Oy. It may not be copied or otherwise distributed without prior written permission from LEDiL Oy.

A3 SHEET 1/1